

版次	变更摘要	日期
1	增加料号说明	2015/1/28
2	配合模具修改后盖外形尺寸	2015/12/10

序号	品名	材质
①	1.0 K型胶芯 (H2.5)	LCP UL94V-0 本色
②	1.0 K型立式端子 (H5.5)	铜合金/表面镀锡
③	1.0 K型卧式后盖 (H2.5)	LCP UL94V-0 黑色
④	1.0 K型立式焊片 (H5.5)	铜合金/表面镀锡

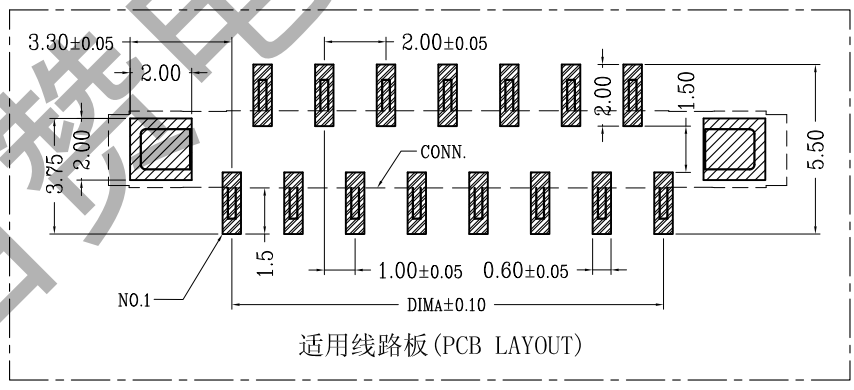
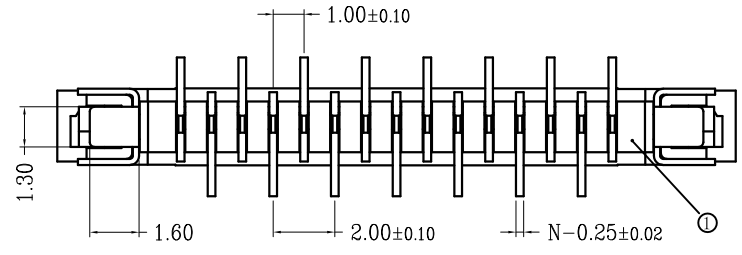
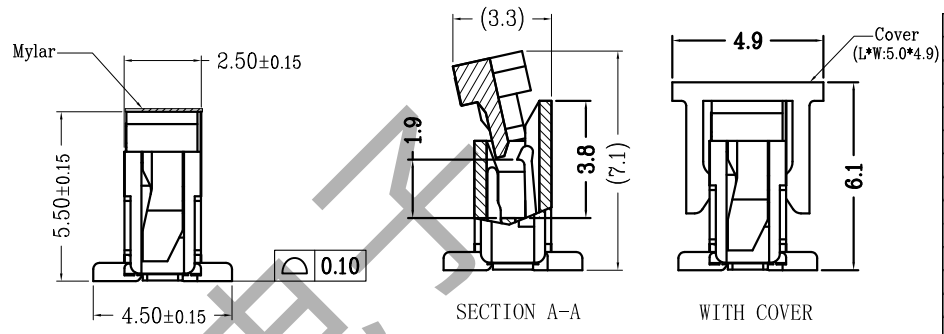
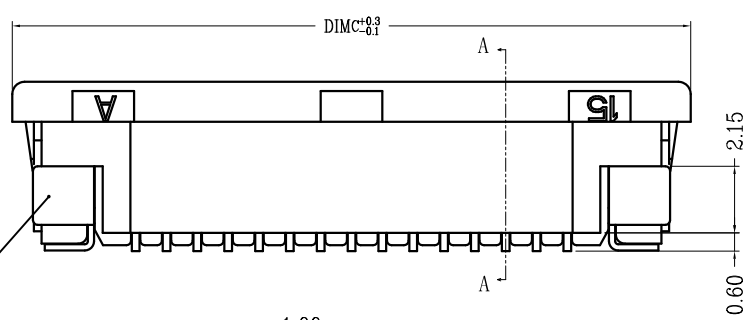
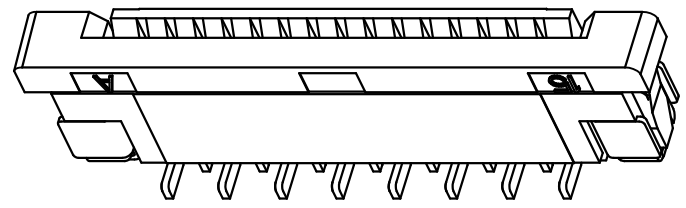
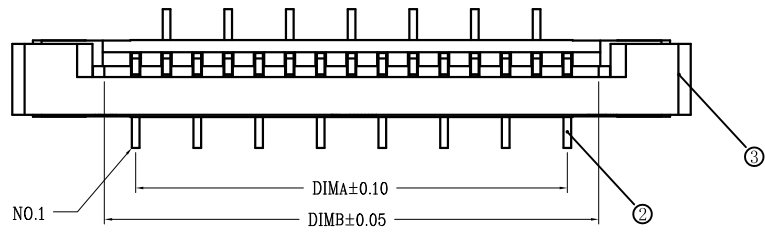

CKT	DIMA	DIMB	DIMC
4	3.00	5.03	11.10
5	4.00	6.03	12.10
6	5.00	7.03	13.10
7	6.00	8.03	14.10
8	7.00	9.03	15.10
9	8.00	10.03	16.10
10	9.00	11.03	17.10
11	10.00	12.03	18.10
12	11.00	13.03	19.10
13	12.00	14.03	20.10
14	13.00	15.03	21.10
15	14.00	16.03	22.10
16	15.00	17.03	23.10
17	16.00	18.03	24.10
18	17.00	19.03	25.10
19	18.00	20.03	26.10
20	19.00	21.03	27.10
21	20.00	22.03	28.10
22	21.00	23.03	29.10
23	22.00	24.03	30.10
24	23.00	25.03	31.10
25	24.00	26.03	32.10
26	25.00	27.03	33.10
27	26.00	28.03	34.10
28	27.00	29.03	35.10
29	28.00	30.03	36.10
30	29.00	31.03	37.10
31	30.00	32.03	38.10
32	31.00	33.03	39.10
33	32.00	34.03	40.10
34	33.00	35.03	41.10
35	34.00	36.03	42.10
36	35.00	37.03	43.10
37	36.00	38.03	44.10
38	37.00	39.03	45.10
39	38.00	40.03	46.10
40	39.00	41.03	47.10

- 技术指标:
1. 塑件表面应光洁、无毛边、无明显收缩、缺陷、裂纹等现象。
  2. 温度范围: -25° C~85° C.
  3. 额定电压: 50V, AC/DC(等效)。
  4. 接触电阻: ≤0.03Ω.
  5. 绝缘电阻: ≥500MΩ
  6. 产品料号:

LL10553-\*\*\* \* \*-2\*

NO OF CKT (产品PIN数) 20 成品2代:后盖有LOGO:WD  
2W 成品2代:后盖无LOGO

Plating (电镀方式)  
0: 端子全雾锡  
1: 端子全金 (G/F OVERALL)

Packing (包装方式)  
T: TUBE管装  
R: TAPE & REEL卷装  
M: TAPE & REEL WITH MYLAR贴MYLAR卷装  
C: TAPE & REEL WITH COVER加吸盖卷装

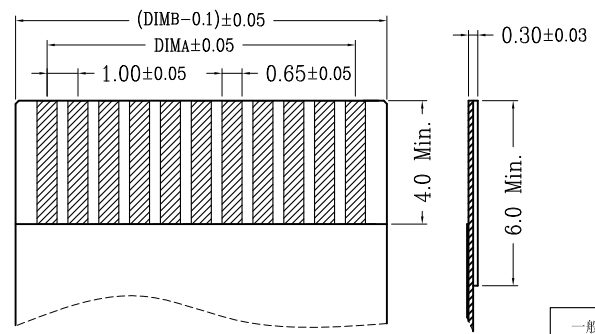

一般公差 (TOLERANCE)  
X ±0.50 XX ±10  
X ±0.20 XXX ±0.5  
ANGLES ±1°

**东莞市百赞电子有限公司**

品名 (TITLE) 1.0 Pitch K型立式正脚位2代	制图 (DR)
料号 (DWG.NO) LL10553-*****-2*	校对 (CHKD)
比例 (SCALE) 1:1	审核 (APPD)
单位 (UNITS) mm	张数 (SHEET) 1 OF 1
尺寸 (SIZE) A4	版本 (REV) A