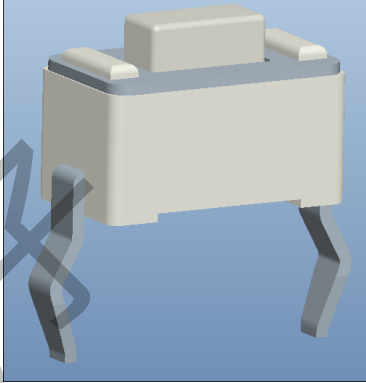

# 承认书

客户名称 CUSTOMER NAME _____	
客户编号 CUSTOMER NO _____	
产品系列 PRODUCT SERIES _____ 轻触开关 TACT SWITCH	
产品型号 PRODUCT TVPE _____ 3X6 插脚	
图型号 DRAWING NO _____	

## 贵公司承认栏

APPROVAL SIGNATURE

印章

请于\_\_\_\_\_年\_\_\_\_\_月\_\_\_\_\_日前承认返

日期 DATE: \_\_\_\_\_

PLEASE RETURN TO US AFTER CONFIRMED! THANK YOU!

DESIGNED BY 制表	CHECKED BY 校对	APPROVED BY 审核
DDATE 日期	DDATE 日期	DDATE 日期

# TACT SWITCH SPECIFICATION

## 轻触开关产品规格书

File No.  
文件编号

Version  
版本

### 一、GENERAL SPECIFICATION 基本说明

- RATING 额定值: 50mA 12V DC
- TYPE OF ACTUATION 动作类型: Tactile feedback 轻触返回
- STANDARD TEST TEMPERATURE SHALL BE 5°C TO 35°C AND HUMIDITY SHALL BE 45% TO 85%.  
温度 5~35°C, 湿度 45~85% 标准状态下测试。
- OPERATING TEMPERATURE RANGE IS -20°C TO 70°C. IT IS USUALLY APPLIED TO ELECTRONIC AND ELECTRICAL APPLIANCE PRODUCTS.  
温度 -20°C~70°C 环境温度内使用。一般适用电子、电器方面产品使用。
- STORAGE TEMPERATURE RANGE: -40~85°C.  
保存温度范围: -40~85°C。

### 二、TEST ITEM 测试项目

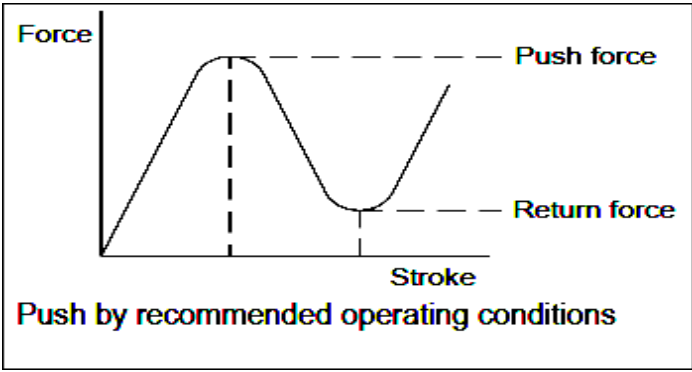
ITEM 项目	TEST CONDITION 测试条件	PERFORMANCE 性能
<b>1 · ELECTRICAL PERFORMANCE 电器性能</b>		
1. 1	CONTACT RESISTANCE 接触电阻 Being tested at 1kHz small current and voltage (50mA, 20mV) by contact resistance meter. 在 1kHz 小电流电压 (50mA, 20mV) 下测量。	100mΩ max. 100 毫欧以下。
1. 2	INSULATION RESISTANCE 绝缘电阻 DC 250V shall be applied for test between terminals and between terminals and frame for one minute. 在端子之间和端子与壳之间加 DC250V 条件下, 持续 1 分钟测量。	100MΩ min. 100 兆欧以上。
1. 3	WITHSTAND VOLTAGE 耐电压 AC 250V and induction current 1mA shall be applied for test between terminals and between terminals and frame for one minute. 在端子之间和端子与壳之间加 AC250V (50Hz 或 60Hz) 感应电流 1mA 条件下, 持续 1 分钟测量。	There shall be no breakdown. 无击穿现象。
<b>2 · MECHANICAL PERFORMANCE 机械性能</b>		
2. 1	OPERATING FORCE 动作力 	160±30gf 260±50gf

# TACT SWITCH SPECIFICATION

## 轻触开关产品规格书

File No.  
文件编号

Version  
版本

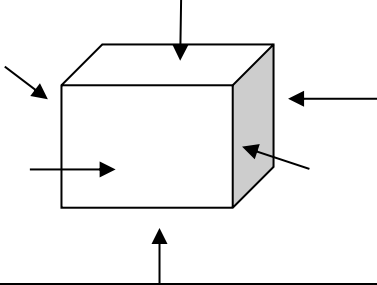
2.2	TRIP 行程	The force exerted 2 times the constant force on the switch and the moving distance at the switch stop. 给开关施加动作力 2 倍不变的力，开关停止时的移动距离。	0.3±0.1mm
2.3	HAND VALUE 手感值	Percentage of switching pressures by the difference of switching pressures minus resilience. 开关按力减去回弹力的差值所占开关按力的百分比	Hand value: 30-75% 手感值: 30-75%
2.4	TERMINAL STRENGTH 端子强度	A static force of 300g being applied in one direction on the tip of the terminal for 1 mintue. 一个 300 克之静负荷施加端子顶部的一个方向持续 1 分钟。	There shall be of mechanical and electrical damage. 无任何迹象显示机械及电器性能之损坏。
2.5	KNOB STRENGTH 手柄强度	Place the switch vertically to the operation direction, test the maximum pulling force that knob can withstand 3KG. 开关垂直于操作方向放置，测量推柄所能承受的最大拉力 3KG	There shall be of mechanical and electrical damage. 无任何迹象显示机械及电器性能之损坏。
2.6	IMPACT SHOCK 冲击	980m/s <sup>2</sup> , 11ms, 3Cycles 6 Directions (Total 18 Cycles) 6 个方向，每个方向 3 次。(18 次)	(1) Contact resistance 200mΩ 接触电阻 200 毫欧以下。 (2) Operating force 30% initial value. 动作力变化范围初始值 30%。 (3) ITEM 项目——1.2 (4) ITEM 项目——1.3 (5) ITEM 项目——2.2
			
<h3>9. DURABILITY 耐久性</h3>			
3.1	SOLDERING TEST 可焊性试验	The tip of the terminal shall be dipped 0.5mm in the solder bath within temperature of 230±5°C for 3s. 端子顶部被侵入锡池 0.5mm 深，温度 230±5°C，时间 3 秒。	Over 95% of the immersed surface was covered by tin . 侵入的部分 95% 以上表面将被锡覆盖

# TACT SWITCH SPECIFICATION

## 轻触开关产品规格书

File No.  
文件编号

Version  
版本

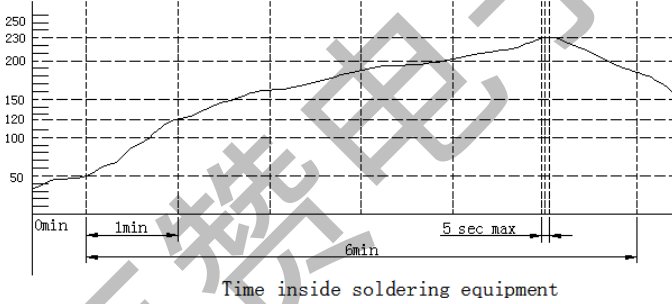
<p>3 · 2</p>	<p>SOLDERING RESISTANT TEST 耐焊性试验</p>	<p>Soldering temperature <math>260 \pm 5^{\circ}\text{C}</math>, soldering time <math>3 \pm 0.5\text{s}</math>, immersion depth up to the surface of the board, thickness of PCB 1.6mm. 焊炉锡的温度控制在 <math>260 \pm 5^{\circ}\text{C}</math>, 时间为 <math>3 \pm 0.5</math> 秒, 与(基板)厚度 1.6mm.</p> <p>Manual soldering temperature <math>350 \pm 5^{\circ}\text{C}</math>, soldering time <math>3 \pm 0.5\text{s}</math>, however excessive pressure shall not be applied to the terminal. 手焊接时温度控制在 <math>350 \pm 5^{\circ}\text{C}</math>, 时间为 <math>3 \pm 0.5</math> 秒, 但不能在端子上施加异常压力。</p>	<p>Without deformation of case or excessive looseness of electrical properties 本体无变形, 能满足与机械、电器性能。</p>
<p>3 · 3</p>	<p>WAVE SOLDERING HEAR TEST 波峰焊接熱試驗</p>	 <p style="text-align: center;">Time inside soldering equipment</p> <p style="text-align: center;">Temperature Profile</p>	<p>Without deformation of case or excessive looseness of electrical properties 本體無變形, 能滿足於機械、電器性能。</p>
<p>3 · 4</p>	<p>LIFE TEST 寿命测试</p>	<p>30, 000cycles of operation at a rate of 100-120 cycles per minute with unloading 无负载条件, 每分钟 100-120 次的速度操作 30, 000 次。</p>	<p>(1) Contact resistance <math>200\text{m}\Omega</math> 接触电阻 200 毫欧以下。 (2) Operating force 30% initial value. 动作力变化范围初始值 30%。 (3) ITEM 项目——1.2 (4) ITEM 项目——1.3 (5) ITEM 项目——2.2</p>

# TACT SWITCH SPECIFICATION

## 轻触开关产品规格书

File No.  
文件编号

Version  
版本

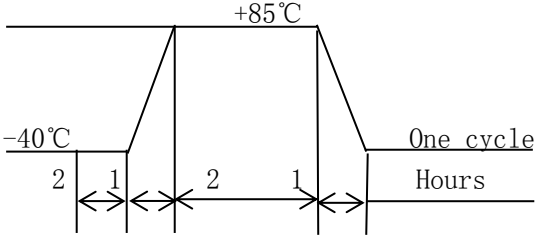
<p>3.5</p>	<p>SALT SPRAY TEST 盐雾</p>	<p>1) Temperature: 35±2°C 2) Cycle: 4Hours testing(1Times) and 1 Hours stop. Based on total 4 hours. 3)Salt solution concentration: 5±1% by weight. 1) 测试温度: 35±2°C 2) 循环次数: 4 小时喷雾 1 小时停, 连续 1 次. 喷雾 4 小时。 3) 盐雾浓度: 5±1%</p>	<p>(1) Contact resistance 200mΩ. 接触电阻 200 毫欧以下。 (2) insulation resistance 100MΩ min. 绝缘电阻 100 兆欧以上。 (3) there shall be no sign of mechanical and electrical damage. 无任何迹象显示机械及电器性能之损坏</p>
<p>3.6</p>	<p>HEAT RESISTANT TEST 耐热试验</p>	<p>80±2°C for 96H, test after keeping in normal condition for 30min. 在 80±2°C 环境中放 96 小时, 再置于正常环境中, 30 分钟后进行测试。</p>	
<p>3.7</p>	<p>MOISTURE RESISTANT TEST 耐湿试验</p>	<p>At 60±2°C 90~95% RH for 96H, test after keeping in normal condition for 30min. 在 60±2°C 90~95% 环境中放 96 小时, 再置于正常环境中, 30 分钟后进行测试。</p>	<p>(1) Contact resistance 200mΩ. 接触电阻 200 毫欧以下。</p>
<p>3.8</p>	<p>COLD RESISTANT TEST 耐冷试验</p>	<p>At -40±2°C for 96H, test after keeping in normal condition for 30min. 在 -40±2°C 环境中放 96 小时, 再置于正常环境中, 30 分钟后进行测试。</p>	<p>(2) insulation resistance 100MΩ min. 绝缘电阻 100 兆欧以上。 (3) there shall be no sign of mechanical and electrical damage. 无任何迹象显示机械及电器性能之损坏</p>
<p>3.9</p>	<p>TEMPERATURE CYCLING TEST 温度交变试验</p>	<p>According to following figure, after 5cycles, test after keeping in normal condition for 1H. 如图示之环境中, 循环 5 次后, 再置于正常环境中, 1 个小时后进行测试。</p> 	<p>(1) Contact resistance 200mΩ. 接触电阻 200 毫欧以下。 (2) insulation resistance 100MΩ min. 绝缘电阻 100 兆欧以上。 (3) there shall be no sign of mechanical and electrical damage. 无任何迹象显示机械及电器性能之损坏</p>

RevNo	Revision note	Date	Signature	Checked
-------	---------------	------	-----------	---------

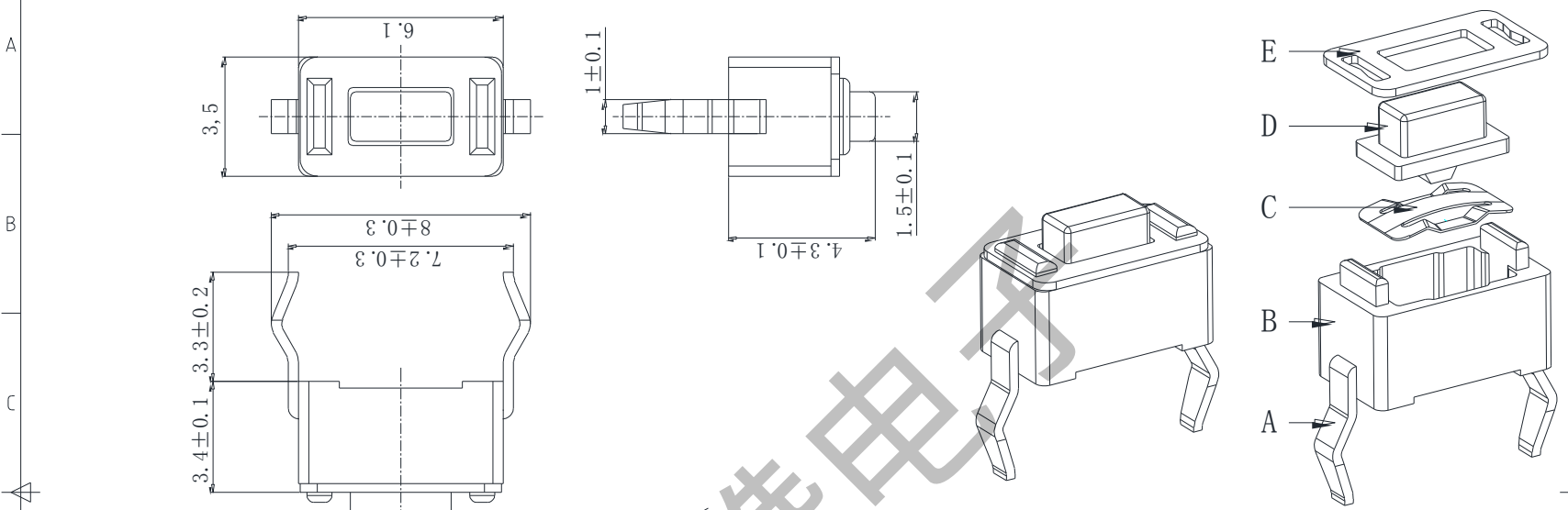

### 技术参数

1. 额定电流: 50mA 12V DC
2. 接触电阻: 100毫欧
3. 按 力: 160±30gf/260±50gf
4. 行 程: 0.3±0.1mm
5. 绝缘电阻: 100兆欧
6. 抗电强度: 100v 50Hz 1Min
7. 寿 命: 3万次

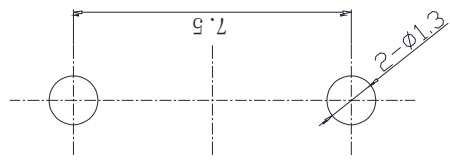

									第一视角	比例	规格型号/ Part No	3X6插脚
E	盖板	铁皮0.25	1	镀铜锡					一般公差	1:1		
D	按钮	PPA	1						>0.5-2	+0.1	单位	产品名称/ Product Name
C	簧片	不锈钢	1		標記	處數	更改文件號	簽字	日期	>2-5	+0.2	3X6插脚
B	基座	PPA	1	清洗						>5以上	+0.3	
A	卡件	黄铜0.3	1	镀银	设计/Designed	审核/Checked	批准/Approved	<b>东莞市百赞电子有限公司</b>				
序号	名称	材 料	数量	备 注								