

承 認 書

PRODUCT APPROVAL SHEET

产品系列 PRODUCT SERIES: 轻触开关

产品名称 PRODUCT TYPE: 3*3*1.5 塑黑头

规格型号 DRAWING NO: _____

制表/DESIGNED BY	校对/CHECKED BY	审核/APPROVED BY	
DATE 日期 20201117	DATE 日期 20201117	DATE 日期 20201117	

贵公司承认栏 APPROVAL SIGNATURE

客户名称/CUSTOMER NAME: _____

物料名称/CUSTOMER TYPE: _____

物料号/CUSTOMER NO: _____

请于_____年_____月_____日前承认返 日期 DATE: _____

PLEASE RETURN TO US AFTER CONFIRMED! THANK YOU!

ISSUE	DATE	WRTN	CHKD
001			

TACT SWITCH SPECIFICATION 轻触开关产品承认书	File No. 文件编号	
	Version 版本	A/0

1、概述 GENERAL

1.1 适用范围 APPLICATION
此规格书适用于机械式轻触开关的相关要求
This specification is applied to the requirements for TACTILE SWITCH(MECHANICAL CONTACT)

1.2 工作温度范围
Operating Temperature Range
-20℃~70℃ (在标准大气压、标准温度条件下)
-20℃~70℃ (Normal humidity, normal air pressure)

1.3 贮藏温度范围
Storage Temperature Rane
-40℃~85℃ (在标准大气压、标准温度条件下)
-40℃~85℃ (Normal humidity, normal air pressure)

1.4 测试条件
Test Conditions
在没有其它特定的条件下，应该在以下的条件下进行测试和测量：
Unless otherwise specified, tests and measurement shall be made in the following standard conditions

常温.....5℃~35℃
Normal temperature.....5℃~35℃
标准湿度.....相对湿度 45%~85%
Normal humidity.....relative humidity 45%~85%
标准大气压.....86KPa~106 KPa
Normal air pressure.....86KPa~106 KPa

在制造过程中，测试和测量应该在以下的条件下进行：
If any doubt arise from the judgment, tests shall be conducted at the following conditions

温度.....20℃±2℃
Temperature.....20℃±2℃
相对湿度.....65%±5%
Relative humidity.....65%±5%
环境气压.....86KPa~106 KPa
Air pressure.....86KPa~106 KPa

2、详细说明 Detailed specification

2.1 外观：应无影响、降低产品性能的缺陷
Appearance: There should be no defects that affect the serviceability of product.

2.2 结构尺寸和安装尺寸：应符合装配图要求
Style and dimension: shall conform to the assemble drawings.

ISSUE	DATE	WRTN	CHKD	Page 2 of 7
001	2020.11.17	WU	ZHANG	

TACT SWITCH SPECIFICATION 轻触开关产品承认书	File No. 文件编号	
	Version 版本	A/0

2.3 操作形式：有触觉反应的操作
Type of actuating:Tactile feedback.

2.4 开关结构：单回路输出（具体的触点结构在装配图中已绘出）
Contact arrangement:1 pole,1 throw
(Details of contact arrangement are given in the assembly drawings.)

2.5 开关工作额定值：DC12V 50mA
Ratings: DC12V 50mA

测试项目 TEST ITEM

3. 电器性能 ELECTRICAL PERFORMANCE

3-1 接触电阻 CONTACT RESISTANCE
在 1kHz 小电流电压（50mA，20mV）下测量。
Being tested at 1kHz small current and voltage (50mA, 20mV) by contact resistance meter.
100 毫欧以下。
100mΩ max.

3-2 绝缘电阻 INSULATION RESISTANCE
在端子之间和端子与壳之间加 DC250V 条件下，持续 1 分钟测量。
DC 250v shall be applied for test between terminals and between terminals and frame for one minute.
100 兆欧以上。
100MΩ min.

3-3 耐电压 WITHSTAND VOLTAGE
在端子之间和端子于壳之间加 AC250V（50Hz 或 60Hz）感应电流 1mA 条件下，持续 1 分钟测量。
AC 250V and induction current 1mA shall be applied for test between terminals and between terminals and frame for one minute.
无击穿现象。
There shall be no breakdown.

4. 机械性能 MECHANICAL PERFORMANCE

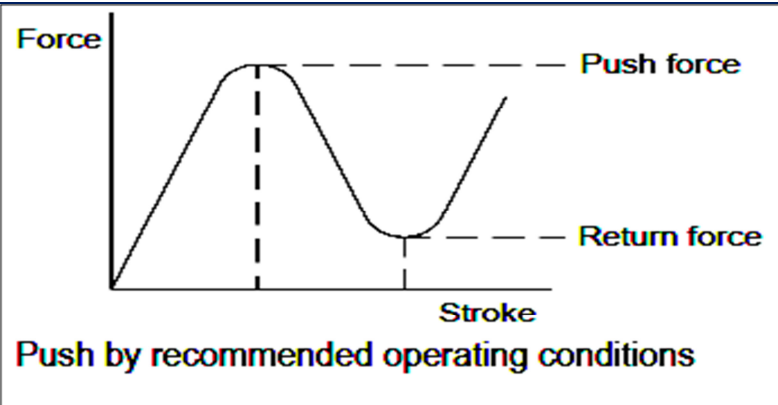
<p>4-1 动作力 OPERATING FORCE</p> <p>160±30gf 260±50gf</p>	 <p style="text-align: center;">Push by recommended operating conditions</p>
--	---

ISSUE	DATE	WRTN	CHKD	Page 3 of 7
001	2020. 11. 17	WU	ZHANG	

TACT SWITCH SPECIFICATION 轻触开关产品承认书	File No. 文件编号	
	Version 版本	A/0

4-2 行程 TRIP

给开关施加动作力 2 倍不变的力，开关停止时的移动距离。

The force exerted 2 times the constant force on the switch and the moving distance at the switch stop.
0.15±0.05mm

4-3 手感值 HAND VALUE

开关按力减去回弹力的差值所占开关按力的百分比 Hand value: 30-70%

Percentage of switching pressures by the difference of switching pressures minus resilience.

手感值: 30-70%

4-4 端子强度 TERMINAL STRENGTH

一个 300 克之静负荷施加端子顶部的一个方向持续 1 分钟。

A static force of 300g being applied in one direction on the tip of the terminal for 1 minute.

无任何迹象显示机械及电器性能之损坏。

There shall be of mechanical and electrical damage.

4-5 手柄强度 KNOB STRENGTH

开关垂直于操作方向放置，测量推柄所能承受的最大拉力 3KG

Place the switch vertically to the operation direction, test the maximum pulling force that knob can withstand 3KG.

无任何迹象显示机械及电器性能之损坏。

There shall be of mechanical and electrical damage.

4-6 冲击 IMPACT SHOCK

6 个方向，每个方向 3 次。(18 次)

980m/s², 11ms, 3Cycles 6 Directions (Total 18 Cycles)

(1) 接触电阻 200 毫欧以下。Contact resistance 200mΩ.

(2) 动作力变化范围初始值 30%。Operating force 30% initial value.

(3) ITEM 项目——1.2

(4) ITEM 项目——1.3

(5) ITEM 项目——2.2

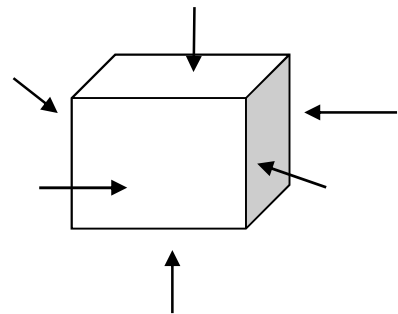

ISSUE	DATE	WRTN	CHKD	Page 4 of 7
001	2020.11.17	WU	ZHANG	

TACT SWITCH SPECIFICATION
轻触开关产品承认书

File No.
文件编号

Version
版本

A/0

5. 耐久性 DURABILITY

5-1 可焊性试验 SOLDERING TEST

端子顶部被侵入锡池 0.5mm 深, 温度 $230 \pm 5^{\circ}\text{C}$, 时间 3 秒。

The tip of the terminal shall be dipped 0.5mm in the solder bath within temperature of $230 \pm 5^{\circ}\text{C}$ for 3s.
侵入的部分 95%以上表面将被锡覆盖

Over 95% of the immersed surface was covered by tin .

5-2 耐焊性试验 SOLDERING RESISTANT TEST

焊炉锡的温度控制在 $260 \pm 5^{\circ}\text{C}$, 时间为 3 ± 0.5 秒, 与(基板)厚度 1.6mm.

Soldering temperature $260 \pm 5^{\circ}\text{C}$, soldering time $3 \pm 0.5\text{s}$, immersion depth up to the surface of the board, thickness of PCB 1.6mm.

手焊接时温度控制在 $350 \pm 5^{\circ}\text{C}$, 时间为 3 ± 0.5 秒, 但不能在端子上施加异常压力。

Manual soldering temperature $350 \pm 5^{\circ}\text{C}$, soldering time $3 \pm 0.5\text{s}$, however excessive pressure shall not be applied to the terminal.

本体无变形, 能满足与机械、电器性能。

Without deformation of case or excessive looseness of electrical properties

5-3 回流焊接热试验 REFLOW SOLDERING
HEAR TEST

本体无变形, 能满足与机械、电器性能。

Without deformation of case or excessive looseness of electrical properties

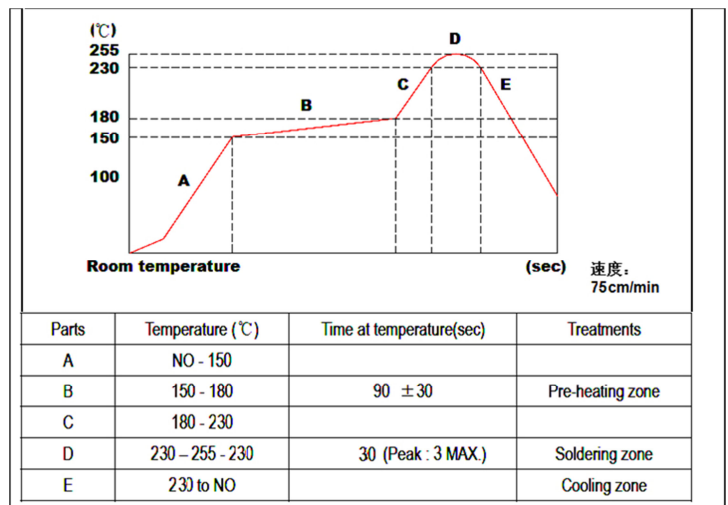

ISSUE

DATE

WR TN

CHKD

001

2020. 11. 17

WU

ZHANG

TACT SWITCH SPECIFICATION 轻触开关产品承认书	File No. 文件编号	
	Version 版本	A/0

5-4 寿命测试 LIFE TEST

无负载条件，每分钟 100-120 次的速度操作 70,000 次。

70,000cycles of operation at a rate of 100-120 cycles per minute with unloading

- (1) 接触电阻 200 毫欧以下。Contact resistance 200mΩ
- (2) 动作力变化范围初始值 30%。Operating force 30% initial value.
- (3) ITEM 项目——1.2
- (4) ITEM 项目——1.3
- (5) ITEM 项目——2.2

5-5 盐雾 SAIL SPRA

1) 测试温度: 35±2℃ Temperature: 35±2℃

2) 循环次数: 8 小时喷雾 1 小时停, 连续 3 次. 喷雾 24 小时. Cycle: 8 Hours testing (3 Times) and 1 Hours stop. Based on total 24 hours.

3) 盐雾浓度: 5±1% Salt solution concentration: 5±1% by weight.

- (1) 接触电阻 200 毫欧以下。Contact resistance 200mΩ.
- (2) 绝缘电阻 100 兆欧以上。Insulation resistance 100MΩ min.
- (3) 无任何迹象显示机械及电器性能之损坏
there shall be no sign of mechanical and electrical damage.

5-6 耐热试验 HEAT RESISTANT TEST

在 80±2℃ 环境中放 96 小时, 再置于正常环境中, 30 分钟后进行测试。
80±2℃ for 96H, test after keeping in normal condition for 30min.

5-7 耐湿试验 MOISTURE RESISTANT TEST

在 60±2℃ 90~95% 环境中放 96 小时, 再置于正常环境中, 30 分钟后进行测试。

At 60±2℃ 90~95% RH for 96H, test after keeping in normal condition for 30min.

5-8 耐冷试验 COLD RESISTANT TEST

在 -40±2℃ 环境中放 96 小时, 再置于正常环境中, 30 分钟后进行测试。
At -40±2℃ for 96H, test after keeping in normal condition for 30min.

5-9 温度交变试验 TEMPERATURE CYCLIG TEST

如图示之环境中, 循环 5 次后, 再置于正常环境中, 1 个小时后进行测试。

According to following figure, after 5cycles, test after keeping in normal condition for 1H.

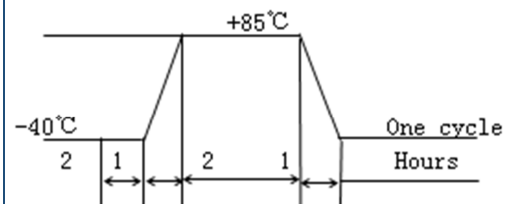

- (1) 接触电阻 200 毫欧以下。
Contact resistance 200mΩ.
- (2) 绝缘电阻 100 兆欧以上。
insulation resistance 100MΩ min.
- (3) 无任何迹象显示机械及电器性能之损坏
there shall be no sign of mechanical and electrical damage.

ISSUE	DATE	WRTN	CHKD	Page 6 of 7
001	2020. 11. 17	WU	ZHANG	

H	
1.5	✓
1.7	
2.0	
2.5	

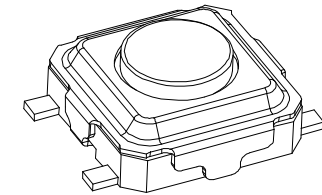
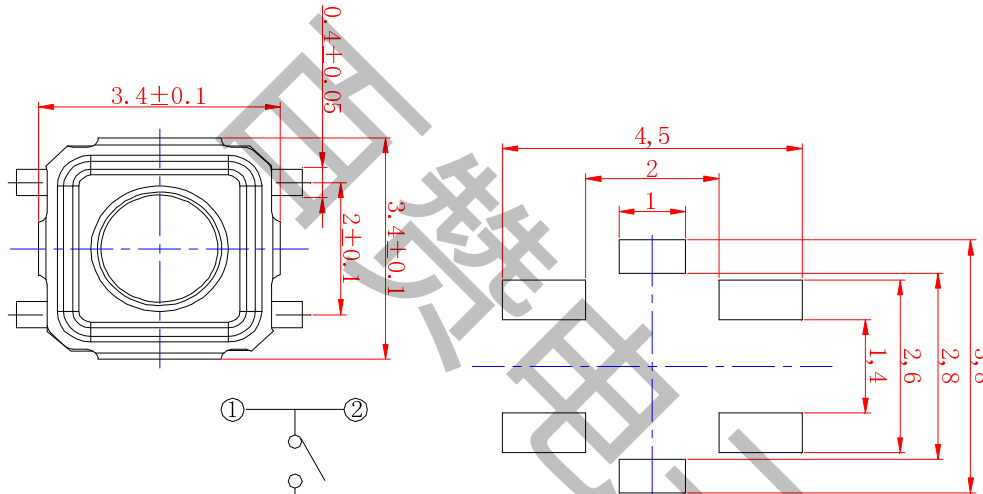
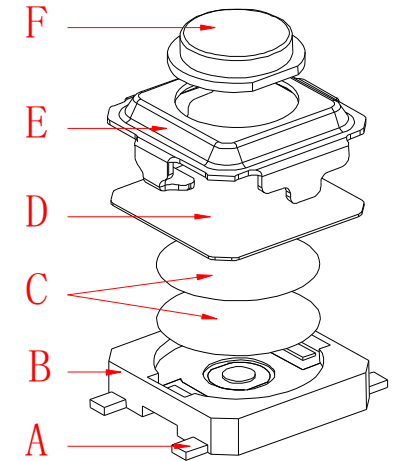
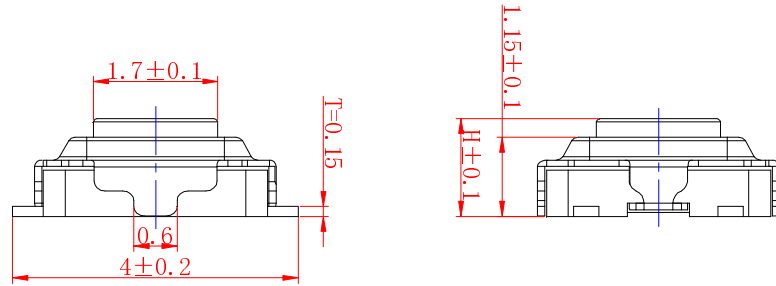

技术参数

1. 额定电流: 50mA 12V DC
2. 接触电阻: 100毫欧
3. 行程: 0.15±0.05 mm
4. 绝缘电阻: 100兆欧
5. 抗电强度: 100v 50Hz 1Min

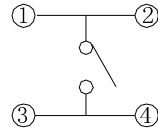

电器原理图

P C B 参考图

按力	160±30gf	260±50gf
寿命	7万次	7万次

E	F	按钮	LCP 黑	1	清洗	第一视角	比例	规格型号/ Part No	产品名称/ Product Name	3*3*1.5 塑黑头			
	E	盖板	不锈钢0.10	1	镀铜锡						一般公差	1:1	
	D	防尘膜	聚酰亚胺	1							>0.5-2	±0.1	单位
	C	簧片	不锈钢覆银	2							>2-5	±0.2	
					標記	處數	更改文件號	簽字	日期	>5以上	±0.3	mm	
										角度	±1°		
F	B	基座	LCP 灰	1	清洗	设计/Designed	审核/Checked	批准/Approved	东莞市百赞电子有限公司				
	A	卡件	磷铜 0.15	1	镀银								
	序号	名称	材料	数量	备注								